



INSTALLATION AND OPERATION MANUAL

FVT/FVR15M2

VIDEO WITH RETURN DATA

The ComNet™ FVT/FVR15M2 series video and data transceiver supports the simultaneous transmission of video and return data over two multimode optical fibers. The module is universally compatible with all major CCTV camera manufacturers and supports RS232 and RS422 data interfaces and all major data protocols. Plug-and-play design ensures ease of installation and no electrical or optical adjustments are ever required.

Each transceiver incorporates a bi-color (Red/Green) indicating LED for monitoring proper system operation. See **Figure 6** on **Page 3** for LED Indicator explanations.

The FVT/FVR15M2 may be directly plugged into the ComNet Rack (Part C1) or may be either wall-mounted, rack-mounted, or DIN-rail mounted by the addition of ComNet model DINBKT1 adaptor plate. See **Figure A** on **Page 4** for mounting instructions.

See **Figures 1 - 6** for complete installation details.

FIGURE 1 - FVT/FVR15M2

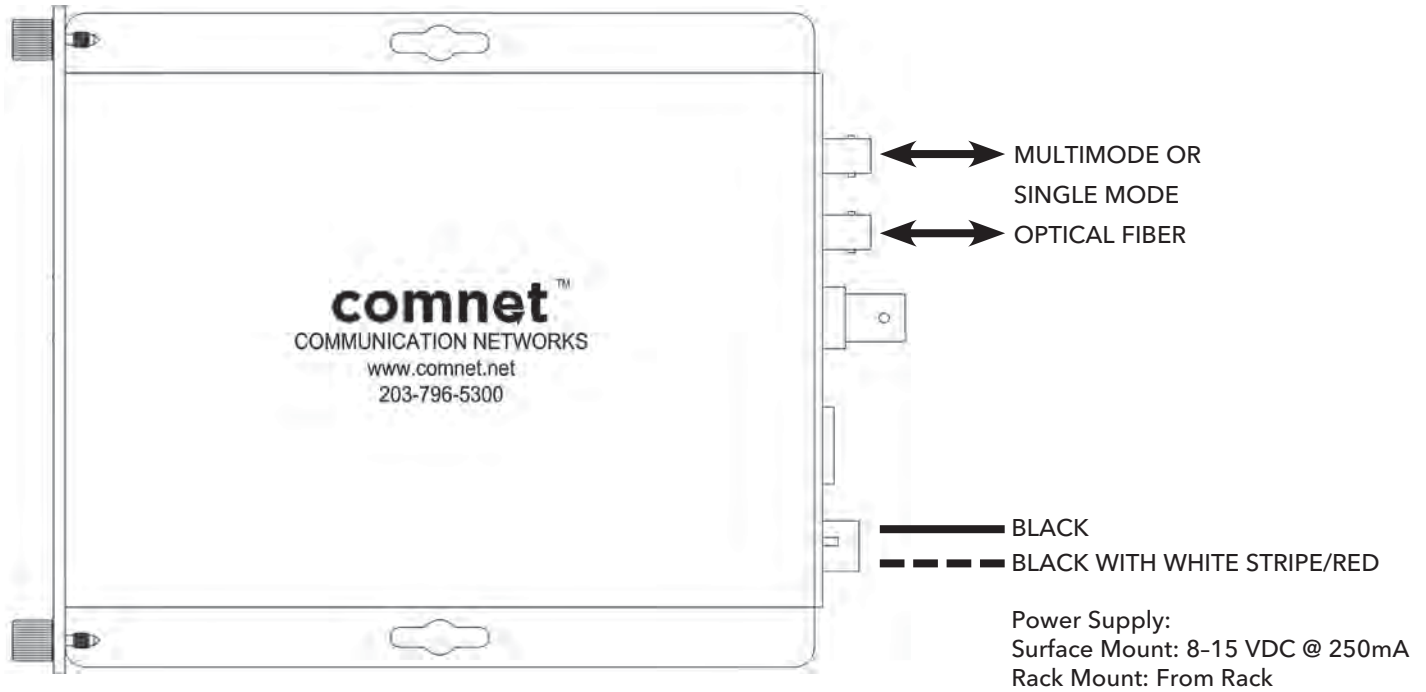

FIGURE 2 - FVT15M2 TRANSMITTER

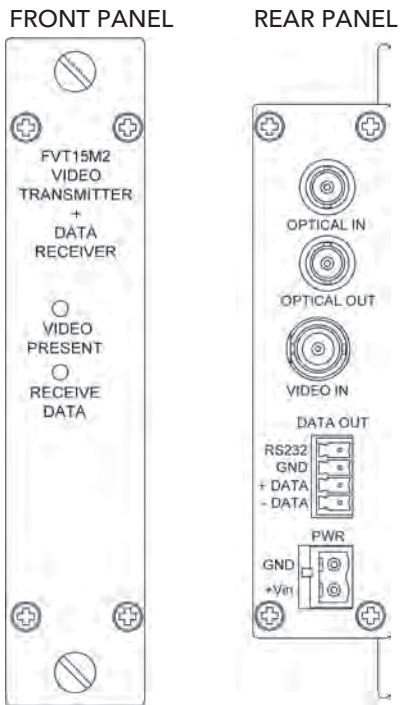
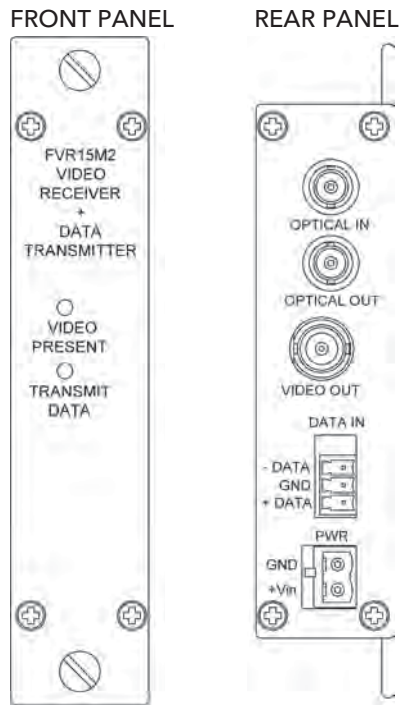

FIGURE 3 - FVR15M2 RECEIVER



NOTE: Remove Electrical Connector for Rack Mount Units

FIGURE 4 - DATA CONNECTIONS

TRANSMITTER

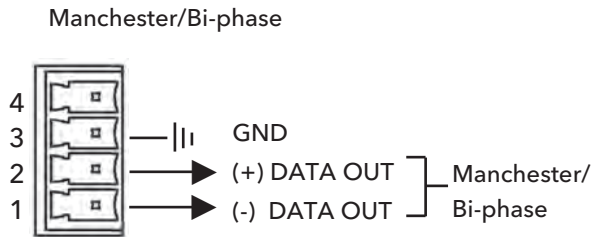
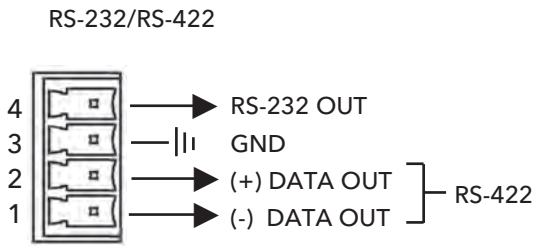

RECEIVER

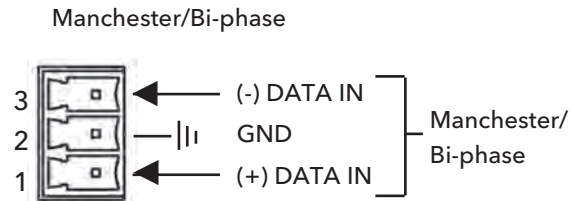
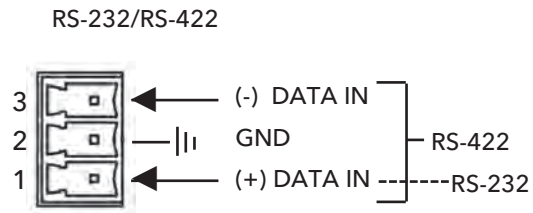

FIGURE 5 - DATA SETTINGS

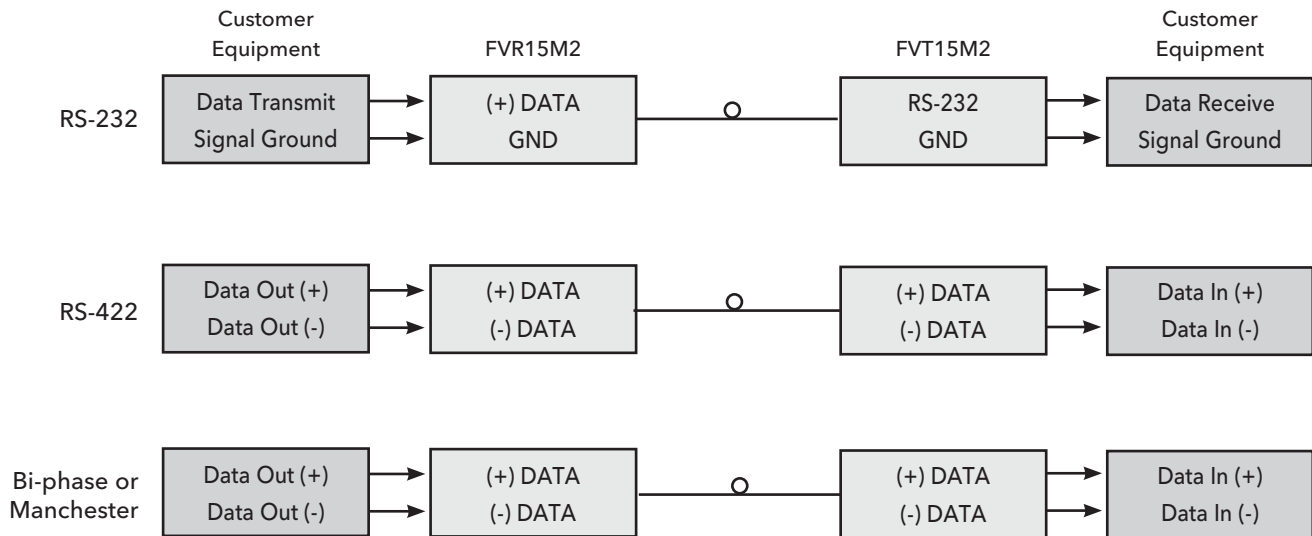

FIGURE 6 - LED INDICATORS

	VIDEO PRESENT	TRANSMIT/RECEIVE DATA
GREEN	Activity	Activity
RED	No Activity	No Activity
OFF	Unit Powered Down	

MECHANICAL INSTALLATION INSTRUCTIONS

INSTALLATION CONSIDERATIONS

This fiber-optic link is supplied as a Standalone/Rack module. Units should be installed in dry locations protected from extremes of temperature and humidity.

C1-US, C1-EU, C1-AU OR C1-CH CARD CAGE RACKS

CAUTION: Although the units are hot-swappable and may be installed without turning power off to the rack, ComNet recommends that the power supply be turned off and that the rack power supply is disconnected from any power source. **Note:** Remove electrical connector before installing in card cage rack.

1. Make sure that the card is oriented right side up, and slide it into the card guides in the rack until the edge connector at the back of the card seats in the corresponding slot in the rack's connector panel. Seating may require thumb pressure on the top and bottom of the card's front panel.

CAUTION: Take care not to press on any of the LEDs.

2. Tighten the two thumb screws on the card until the front panel of the card is seated against the front of the rack.

WARNING: Unit is to be used with a Listed Class 2 or LPS power supply rated 8-15 VDC @ 250 mA.

IMPORTANT SAFEGUARDS:

- A) Elevated Operating Ambient** - If installed in a closed or multi-unit rack assembly, the operating ambient temperature of the rack environment may be greater than room ambient. Therefore, consideration should be given to installing the equipment in an environment compatible with the maximum ambient temperature (T_{ma}) specified by the manufacturer.
- B) Reduced Air Flow** - Installation of the equipment in a rack should be such that the amount of air flow required for safe operation of the equipment is not compromised.

FIGURE A

Dimensions are for a standard ComNet one slot module

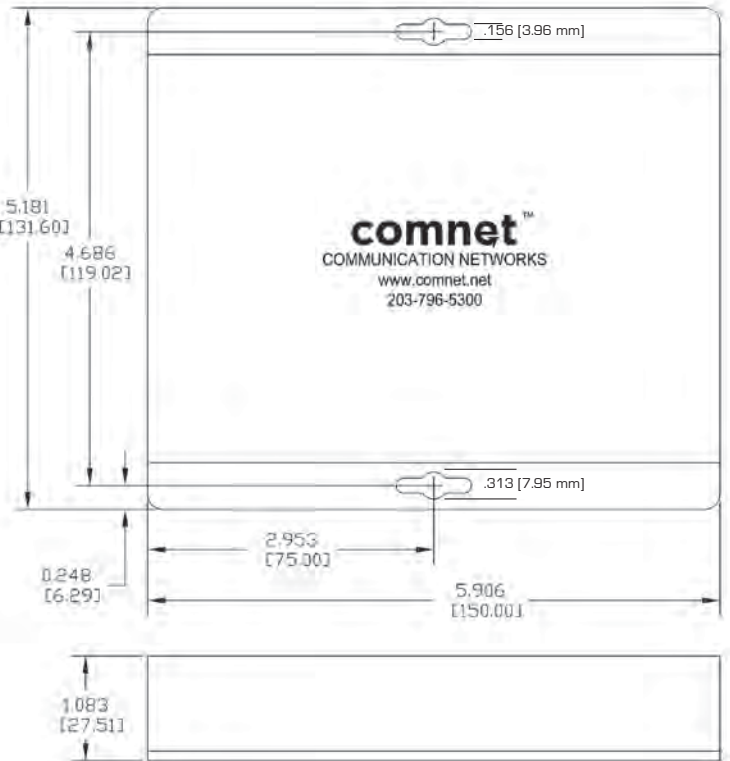

MADE IN THE
USA

comnet

3 CORPORATE DRIVE | DANBURY, CT 06810 | USA
T: 203.796.5300 | F: 203.796.5303 | TECH SUPPORT: 1.888.678.9427 | INFO@COMNET.NET

8 TURNBERRY PARK ROAD | GILDERSOME | MORLEY | LEEDS, UK LS27 7LE
T: +44 (0)113 307 6400 | F: +44 (0)113 253 7462 | INFO-EUROPE@COMNET.NET