



INSTALLATION AND OPERATION MANUAL

FVT/FVR80D4SFP

8-CHANNEL DIGITALLY ENCODED VIDEO
+ 4 CHANNELS OF BI-DIRECTIONAL DATA USING
SMALL FORM-FACTOR PLUGGABLE (SFP) OPTICAL DEVICES

The FVT/FVR80D4SFP series optical video link provides transmission of eight 10-bit medium-haul quality digitally encoded video channels and four bi-directional data channels through a selectable small form factor pluggable module (SFP). See instructions included with SFP for installation of selected module.

Figure 5 on Page 3 illustrates the data electrical connections from the RJ45 Data connectors and also the connection cable and “breakout box” connections.

Figure 7 on Page 4 illustrates the specific data connections for RS232, 2-Wire RS485 and RS422/4-Wire RS485. (This last data connection also applies to Manchester & Bi-Phase data transmission.)

Each data channel is configured for the electrical interface by means of the “DATA SELECT” switch on the front panel. **Figure 6 on Page 4** illustrates the switch settings to set the type of data for each channel.

Figure 8 on Page 5 illustrates the electrical connections between the “Customer Equipment” and the FVT80D4SFP and FVR80D4SFP.

Bi-color (Red/Green) LED indicators are provided for confirming operating status. See **Figure 4 on Page 3** for LED indication explanations.

These units are interchangeable between stand-alone or card mount configurations. See **Figure A on Page 6** for mounting instructions.

FIGURE 1 – FVT/FVR80D4SFP TRANSMITTER AND RECEIVER

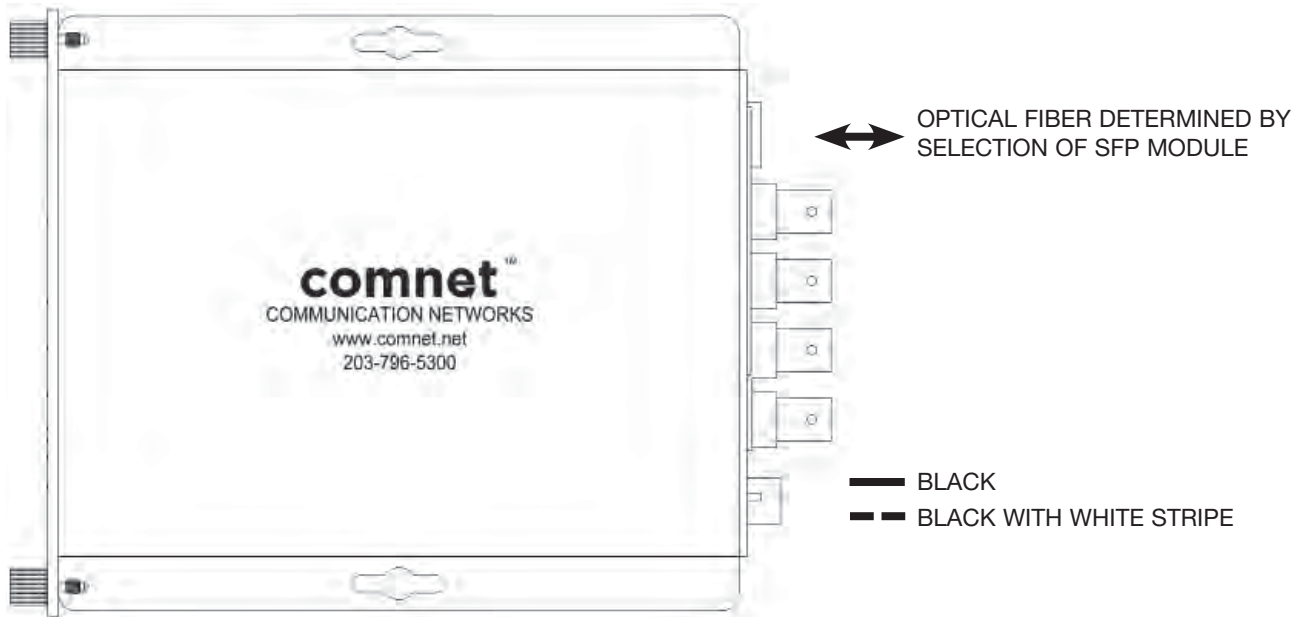

FIGURE 2 – FVT80D4SFP TRANSMITTER

FRONT PANEL

REAR PANEL

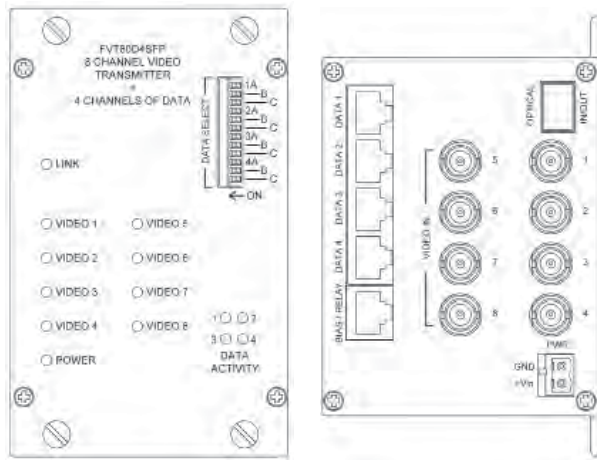
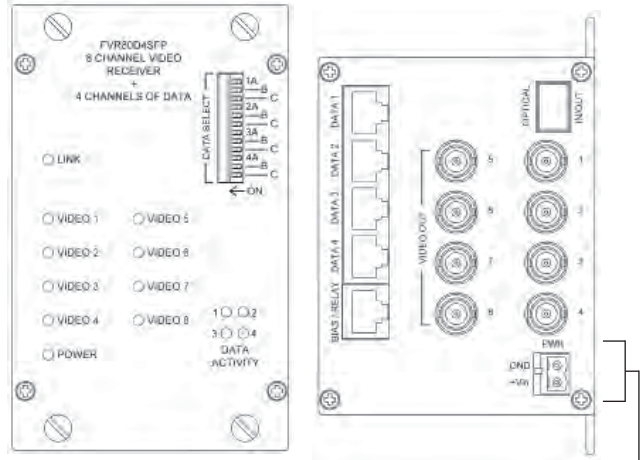

FIGURE 3 – FVR80D4SFP RECEIVER

FRONT PANEL

REAR PANEL



NOTE: Remove Electrical Connector for Rack Mount Units

FIGURE 4 – LED INDICATORS

	LINK	VIDEO	DATA (IN/OUT)	POWER
GREEN	Communication link has been established over optical fiber	An active video signal is present on the BNC connector.	An active video signal is present on the BNC connector.	Unit powered up
RED	Communication link has not been established.	No Video Signal	–	–
OFF	Not powered up correctly	–	No Video Signal	Unit powered down

FIGURE 5 – RJ45 BREAK-OUT ASSEMBLY

5 pc. Factory Supplied

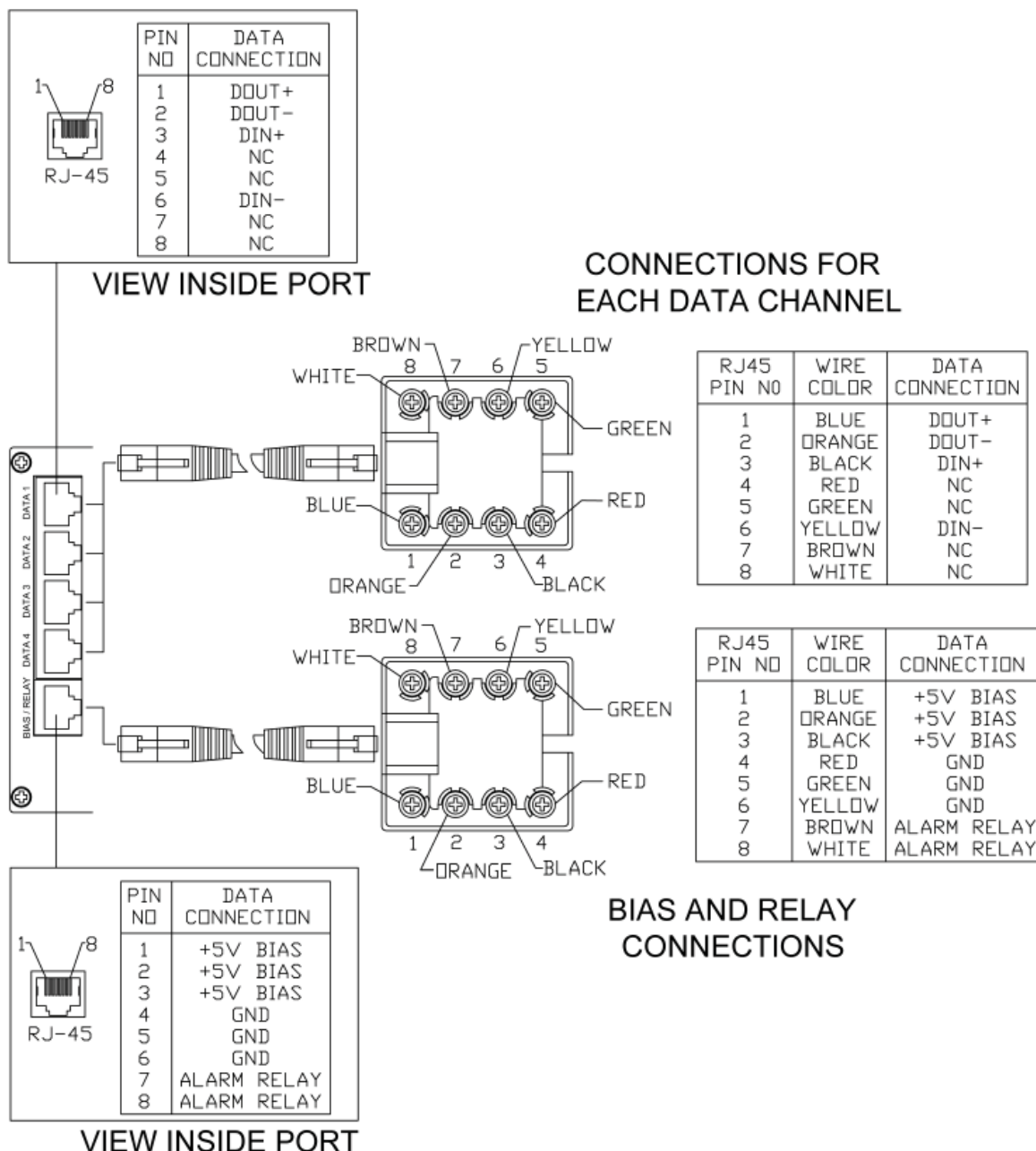

FIGURE 6 – SWITCH POSITIONS – FRONT PANEL

The mode for each data channel is configured using a set of three switches on the front panel of the unit.

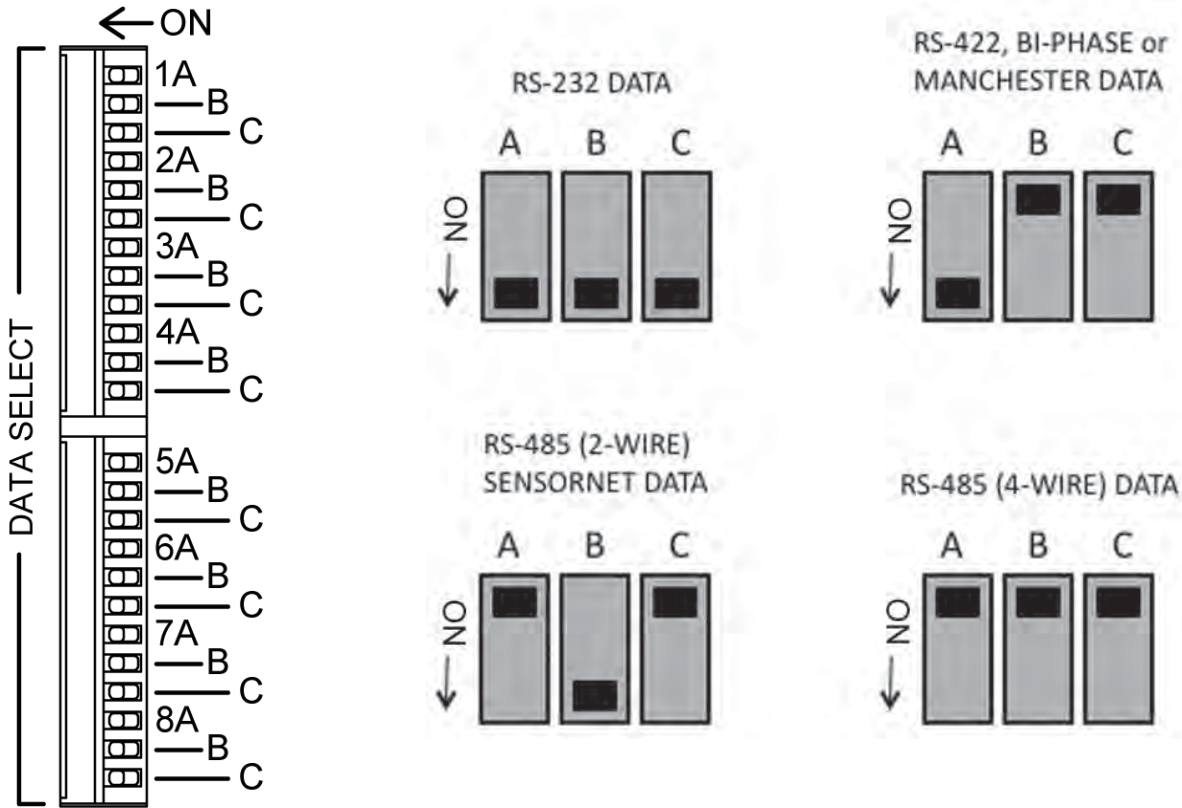
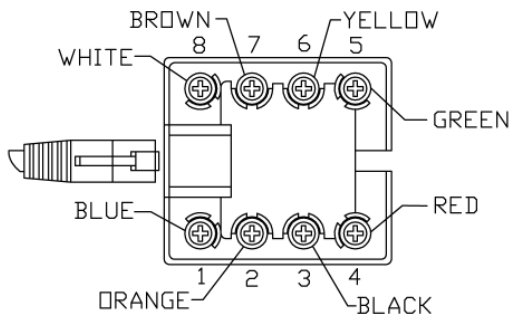

FIGURE 7 – SWITCH POSITIONS – RJ45



RJ45 PIN NO	WIRE COLOR	DATA CONNECTION
1	BLUE	DOUT+
2	ORANGE	DOUT-
3	BLACK	DIN+
4	RED	NC
5	GREEN	TERMINATION
6	YELLOW	DIN-
7	BROWN	GND
8	WHITE	+5V BIAS

RS232

- 1 NC
- 2 Out (-)
- 3 Ground
- 4 NC
- 5 NC
- 6 IN (-)
- 7 NC
- 8 NC

RS485 (2W)

& SENSORNET

- 1 NC
- 2 NC
- 3 IN (+)
- 4 NC
- 5 NC
- 6 IN (-)
- 7 NC
- 8 NC

RS422, RS485

(4W), Manchester & Bi-Phase

- 1 OUT (+)
- 2 OUT (-)
- 3 IN (+)
- 4 NC
- 5 NC
- 6 IN (-)
- 7 NC
- 8 NC

NC = No Connection

FIGURE 8 – DATA CONNECTIONS

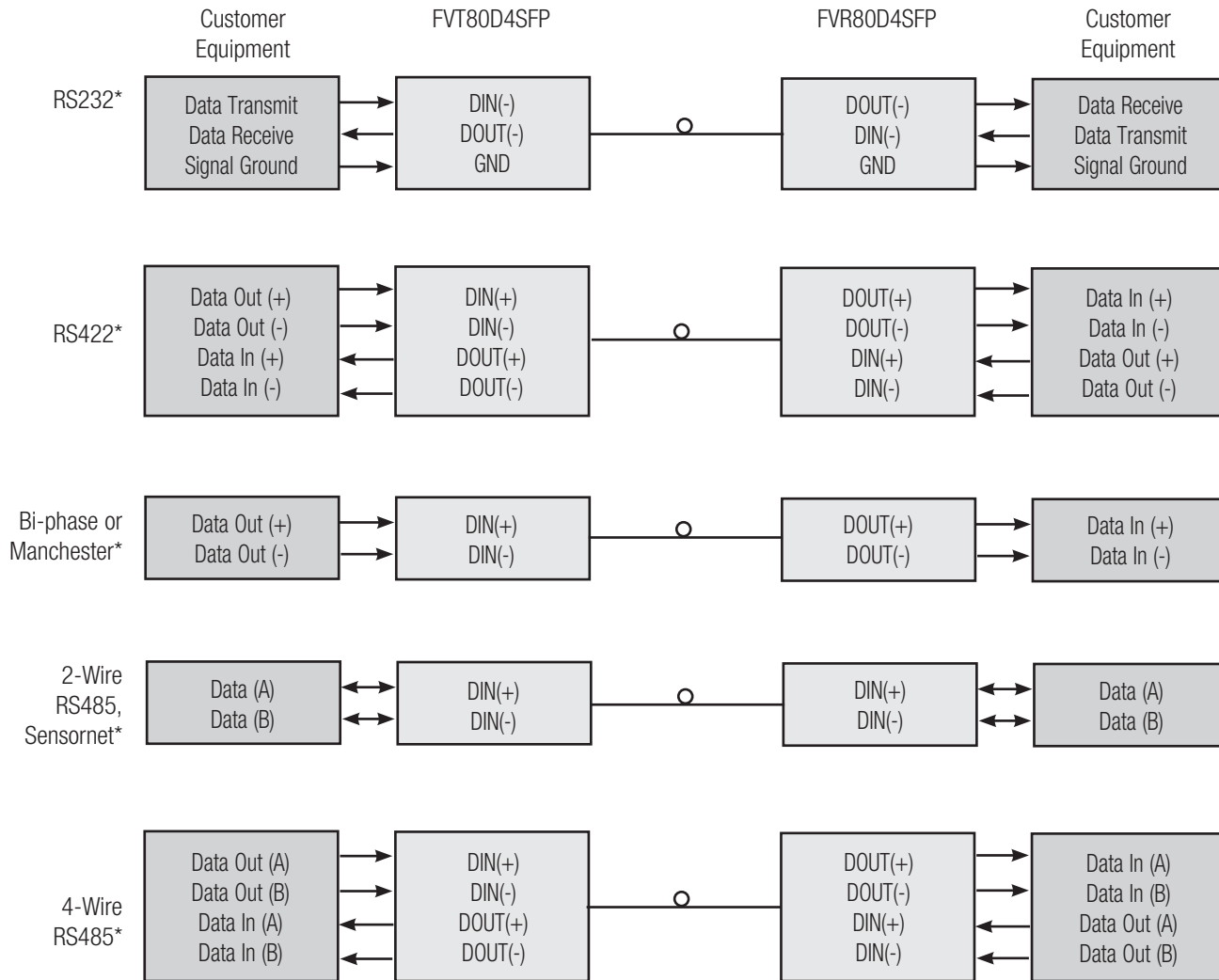

* See Page 5 for Switch Settings

MECHANICAL INSTALLATION INSTRUCTIONS

INSTALLATION CONSIDERATIONS

This fiber-optic link is supplied as a Standalone/Rack module. Units should be installed in dry locations protected from extremes of temperature and humidity.

C1-US, C1-EU, C1-AU OR C1-CH CARD CAGE RACKS

CAUTION: Although the units are hot-swappable and may be installed without turning power off to the rack, ComNet recommends that the power supply be turned off and that the rack power supply is disconnected from any power source. **Note:** Remove electrical connector before installing in card cage rack.

1. Make sure that the card is oriented right side up, and slide it into the card guides in the rack until the edge connector at the back of the card seats in the corresponding slot in the rack's connector panel. Seating may require thumb pressure on the top and bottom of the card's front panel.

CAUTION: Take care not to press on any of the LEDs.

2. Tighten the two thumb screws on the card until the front panel of the card is seated against the front of the rack.

WARNING: Unit is to be used with a Listed Class 2 or LPS power supply rated 9-12 VDC @ 1A.

IMPORTANT SAFEGUARDS:

- A) Elevated Operating Ambient** - If installed in a closed or multi-unit rack assembly, the operating ambient temperature of the rack environment may be greater than room ambient. Therefore, consideration should be given to installing the equipment in an environment compatible with the maximum ambient temperature (T_{ma}) specified by the manufacturer.
- B) Reduced Air Flow** - Installation of the equipment in a rack should be such that the amount of air flow required for safe operation of the equipment is not compromised.

FIGURE A

Dimensions are for a standard ComNet™ three slot module

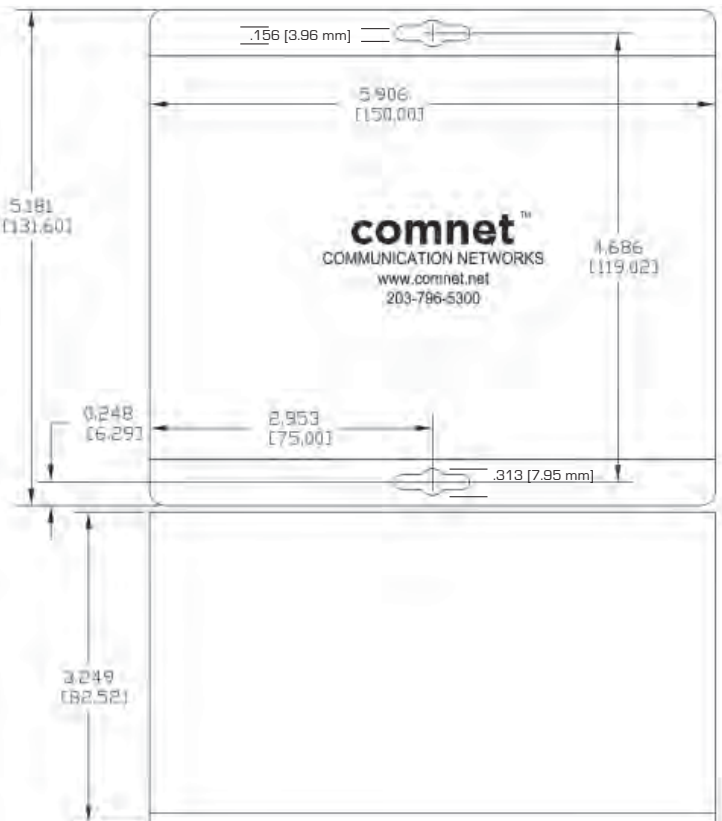

MADE IN THE
USA

comnet
Communication Networks

3 CORPORATE DRIVE | DANBURY, CT 06810 | USA
T: 83.796.5300 | F: 83.796.5303 | TECH SUPPORT: 1.888.678.9427 | INFO@COMNET.NET

8 TURNBERRY PARK ROAD | GILDERSOME | MORLEY | LEEDS, UK LS27 7LE
T: +44 (0)113 307 6400 | F: +44 (0)113 253 7462 | INFO-EUROPE@COMNET.NET