



## INSTALLATION AND OPERATION MANUAL

### FVT/FVR8012

8-CHANNEL 10-BIT DIGITALLY ENCODED VIDEO  
+ 2 BI-DIRECTIONAL DATA CHANNELS  
+ 1 BI-DIRECTIONAL CONTACT CLOSURE

The FVT/FVR8012(M,S)1 Series transmits eight (8) channels of video utilizing state of the art 10-bit digital encoding and decoding for very high quality video transmission, along with two (2) channels of bi-directional data and one (1) bi-directional contact closure over one single mode or multimode optical fiber.

This equipment is environmentally hardened and suitable for use in unconditioned roadside or out-of plant installations.

The FVT/FVR8012 is compatible with NTSC, PAL and SECAM video transmission protocols and supports bi-directional RS232, 422 and 485 (2 & 4 Wire) data. See **Figure 4** on **Page 3** for data selection.

See **Figure 6** on **Page 5** for contact switch positions.

Bi-Color LED indicators are provided to indicate the status of the system, video and data. See **Figure 7** on **Page 5** for LED indication explanations.

These units may be directly plugged into the ComNet Rack (Part C1) or they can operate as standalone modules. See **Figure A** on **Page 6** for mounting instructions.

See **Figures 1 - 7** for complete installation details. No additional parts or power supplies are required.

FIGURE 1 - FVT/FVR8012 TRANSMITTER AND RECEIVER

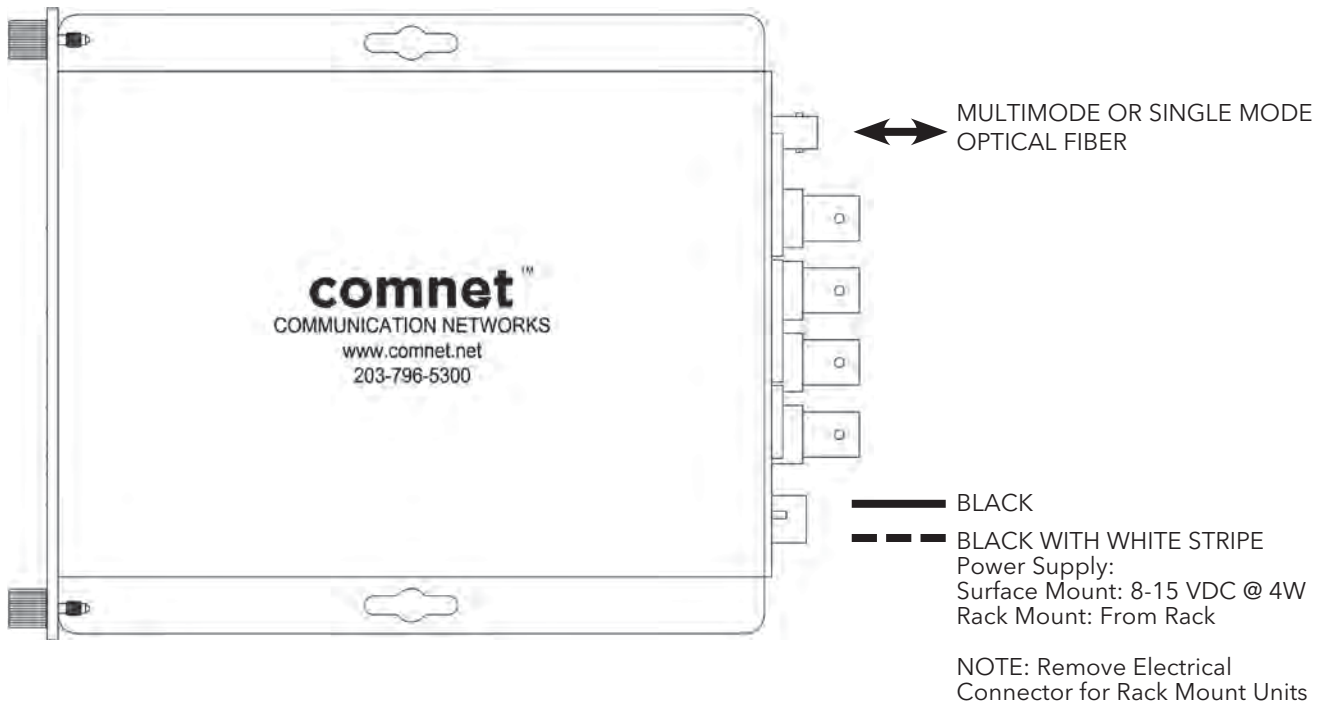

FIGURE 2 - FVT8012 TRANSMITTER

FRONT PANEL

REAR PANEL

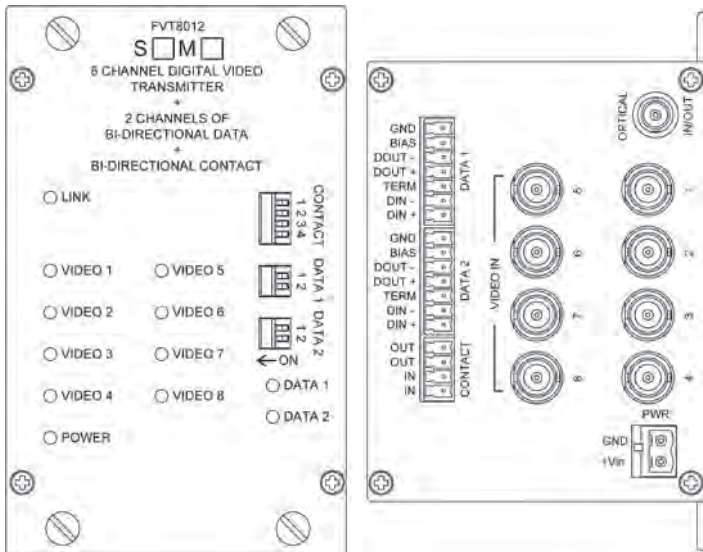
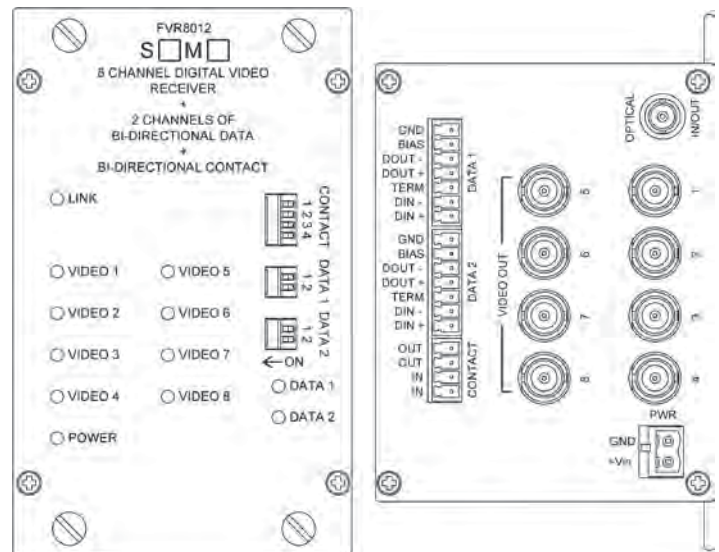

FIGURE 3 - FVR8012 RECEIVER

FRONT PANEL

REAR PANEL



**FIGURE 4 - DATA SWITCH POSITIONS**

The mode for each data channel is configured using a pair switches on the front panel of the unit.

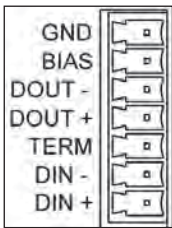
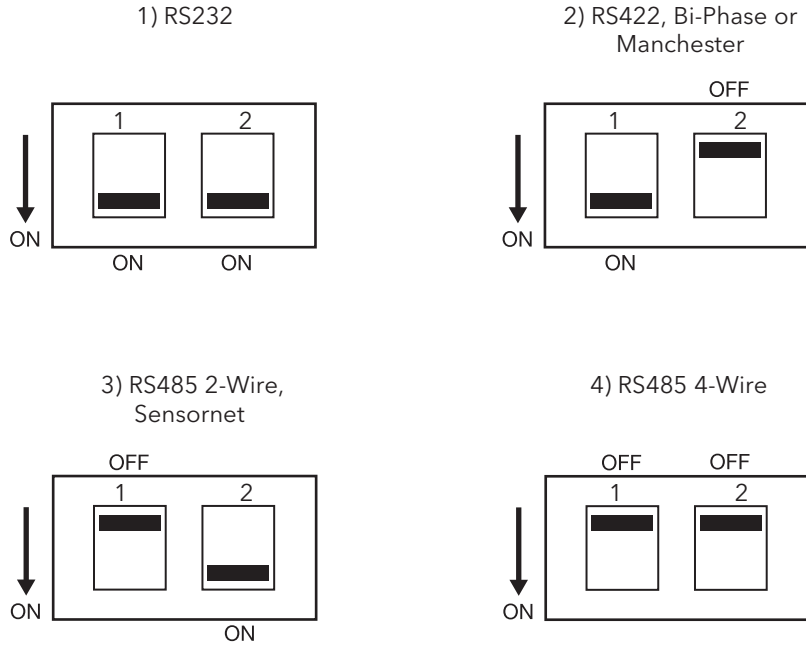
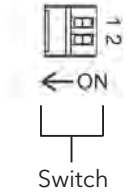

- |                                                                                                            |                                                                                                                                                                                             |                                                                                                                             |                                                                                                                                                                              |
|------------------------------------------------------------------------------------------------------------|---------------------------------------------------------------------------------------------------------------------------------------------------------------------------------------------|-----------------------------------------------------------------------------------------------------------------------------|------------------------------------------------------------------------------------------------------------------------------------------------------------------------------|
| <p><b>1) RS232</b><br/>                 DIN (-)<br/>                 DOUT (-)<br/>                 GND</p> | <p><b>2) RS422, Bi-Phase, Manchester</b><br/>                 DIN (+)<br/>                 DIN (-)<br/>                 DOUT (+)<br/>                 DOUT (-)<br/>                 GND</p> | <p><b>3) RS485 2-Wire, Sensornet</b><br/>                 DIN (+)<br/>                 DIN (-)<br/>                 GND</p> | <p><b>4) RS485 4-Wire</b><br/>                 DIN (+)<br/>                 DIN (-)<br/>                 DOUT (+)<br/>                 DOUT (-)<br/>                 GND</p> |
|------------------------------------------------------------------------------------------------------------|---------------------------------------------------------------------------------------------------------------------------------------------------------------------------------------------|-----------------------------------------------------------------------------------------------------------------------------|------------------------------------------------------------------------------------------------------------------------------------------------------------------------------|

**Termination Note**  
 A 120 ohm termination resistor is applied to the differential inputs when TERM is wired directly to DIN - (see diagram below).

FIGURE 5 - DATA CONNECTIONS

See Page 3 for Switch Settings

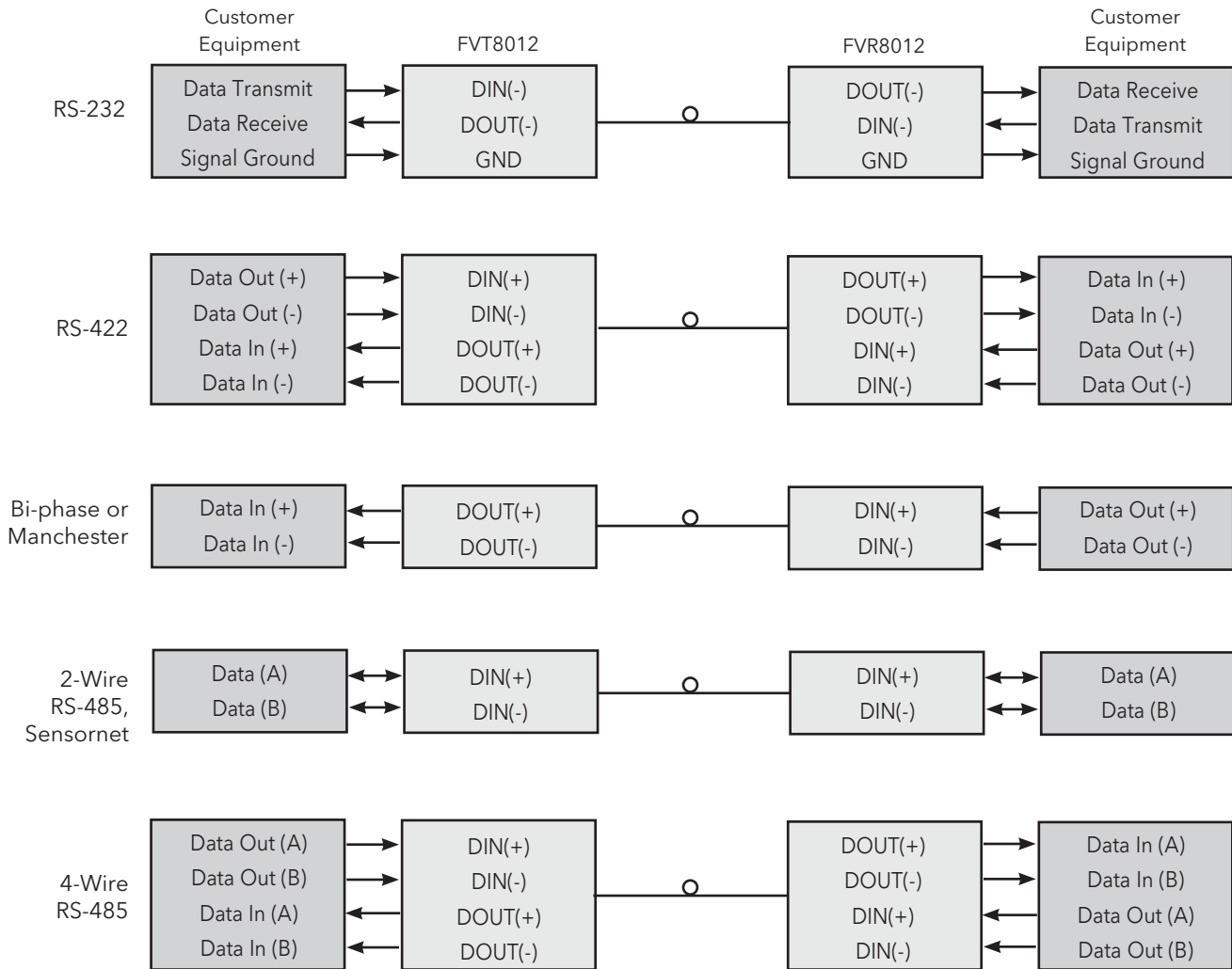
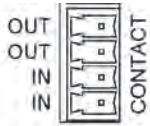

FIGURE 6 - CONTACT SWITCH POSITIONS



The four CONTACT switches on the front of the unit set the operating mode of the CONTACT OUT terminal pair.

It can either function as an alarm to indicate fault conditions, or it can function as a contact closure to indicate the state of the CONTACT IN terminal pair on the rear of the unit at the other end of the fiber.



1	2	3	4	
ON	OFF	OFF	OFF	Closed when optical Port has established link. Open when Optical Port has lost link.
ON	ON	ON	OFF	Closed when Optical Port has established link and all video signals are present. Open when Optical Port has lost Link, or if a Video signal is lost.
ON	ON	ON	ON	Contact Closure mode. State based on CONTACT IN at other end of fiber link.

FIGURE 7 - LED INDICATORS

	LINK	VIDEO (1 - 8)	DATA (1 - 2)	POWER
<b>GREEN</b>	Communication link has been established over optical fiber	Active video signal present on the BNC connector.	Active data signal present	Unit powered up
<b>RED</b>	Communication link has not been established	No video signal	No data signal	-
<b>OFF</b>	Not powered up correctly	-	-	Unit powered down

# MECHANICAL INSTALLATION INSTRUCTIONS

## INSTALLATION CONSIDERATIONS

This fiber-optic link is supplied as a Standalone/Rack module. Units should be installed in dry locations protected from extremes of temperature and humidity.

## C1-US, C1-EU, C1-AU OR C1-CH CARD CAGE RACKS

**CAUTION:** Although the units are hot-swappable and may be installed without turning power off to the rack, ComNet recommends that the power supply be turned off and that the rack power supply is disconnected from any power source. **Note:** Remove electrical connector before installing in card cage rack.

1. Make sure that the card is oriented right side up, and slide it into the card guides in the rack until the edge connector at the back of the card seats in the corresponding slot in the rack's connector panel. Seating may require thumb pressure on the top and bottom of the card's front panel.

**CAUTION:** Take care not to press on any of the LEDs.

2. Tighten the two thumb screws on the card until the front panel of the card is seated against the front of the rack.

**WARNING:** Unit is to be used with a Listed Class 2 or LPS power supply

### IMPORTANT SAFEGUARDS:

- A) Elevated Operating Ambient** - If installed in a closed or multi-unit rack assembly, the operating ambient temperature of the rack environment may be greater than room ambient. Therefore, consideration should be given to installing the equipment in an environment compatible with the maximum ambient temperature (T<sub>ma</sub>) specified by the manufacturer.
- B) Reduced Air Flow** - Installation of the equipment in a rack should be such that the amount of air flow required for safe operation of the equipment is not compromised.

**FIGURE A**

Dimensions are for a standard ComNet™ three slot module

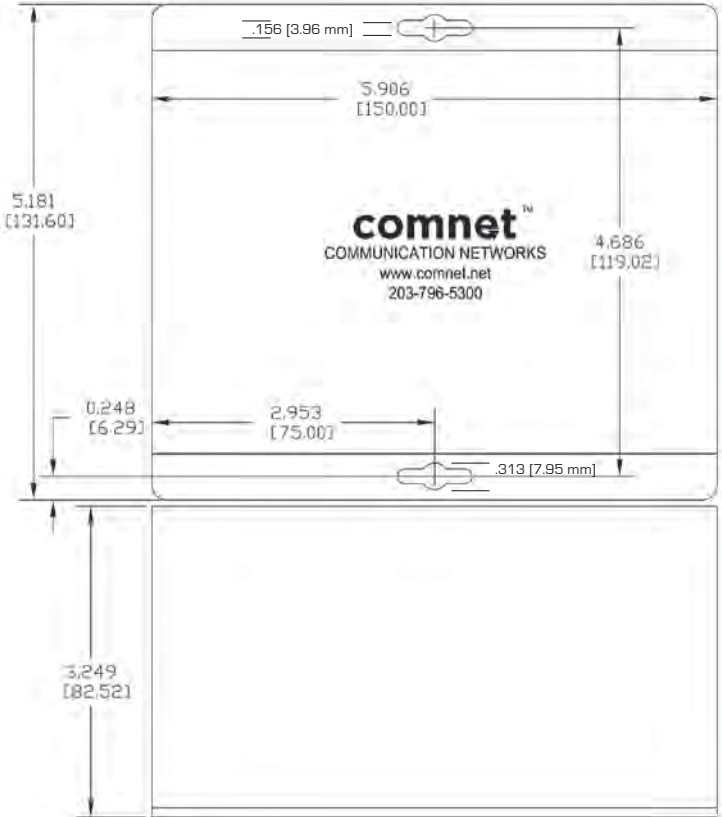

MADE IN THE  
**USA**

**comnet**  
Communication Networks

3 CORPORATE DRIVE | DANBURY, CT 06810 | USA  
T: 203.796.5300 | F: 203.796.5303 | TECH SUPPORT: 1.888.678.9427 | INFO@COMNET.NET  
8 TURNBERRY PARK ROAD | GILDERSOME | MORLEY | LEEDS, UK LS27 7LE  
T: +44 (0)113 307 6400 | F: +44 (0)113 253 7462 | INFO-EUROPE@COMNET.NET