



## INSTALLATION AND OPERATION MANUAL

# FDX72(M,S)1SHR

## MULTI-PROTOCOL RS232/422/485 DATA TRANSCEIVER FEATURING SELF-HEALING RING OPERATION

The ComNet™ FDX72(M,S)1SHR series Self-Healing Ring Transceiver unit is a fully-digital transceiver designed for implementing full RS232, RS422 or RS485 2 or 4-wire traffic signalization/communications data networks of the highest possible reliability. A network of FDX72SHR units can support one full-duplex data channel or two half-duplex data channels. Full data re-clocking and regeneration permit an almost unlimited number of transceiver/controller units to be used within the network. These environmentally hardened transceivers are ideal for use in unconditioned out-of-plant or roadside installations.

Utilizing wave division multiplexing technology (WDM), only one optical fiber is required between units to implement a fully self-healing ring. Two FDX72SHR units can be used in a redundant point-to-point topology.

Bi-color (Red/Green) LED indicators are provided for rapidly ascertaining equipment operating status including the location of fiber breaks. See **Figure 7** on **Page 5** for an explanation of LED indications.

These units are interchangeable between stand-alone or card-cage mount configurations. See **Figure A** on **Page 7** for mounting instructions.

See **Figures 1 - 8** for complete installation details.

FIGURE 1 - FDX72SHR FIBER CONNECTIONS

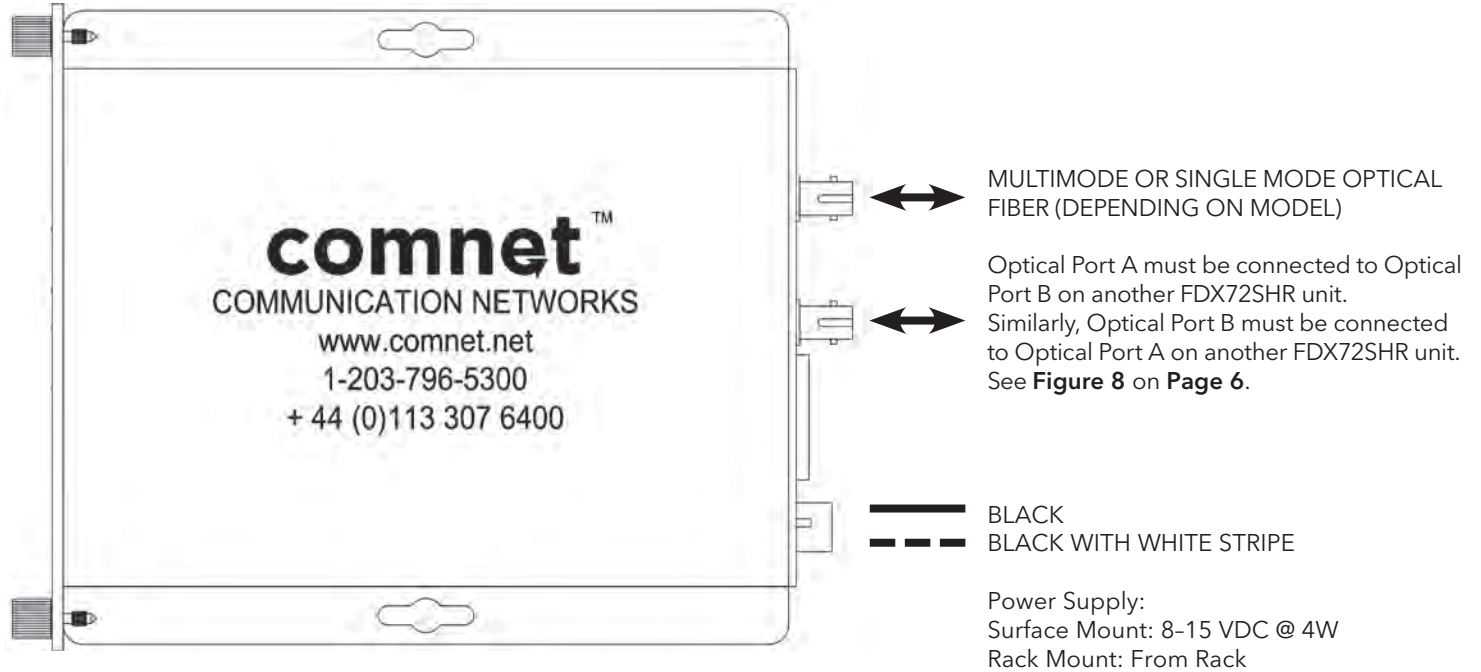

NOTE: Remove Electrical Connector for Rack Mount Units

FIGURE 2 - FDX72SHR

FRONT PANEL

REAR PANEL

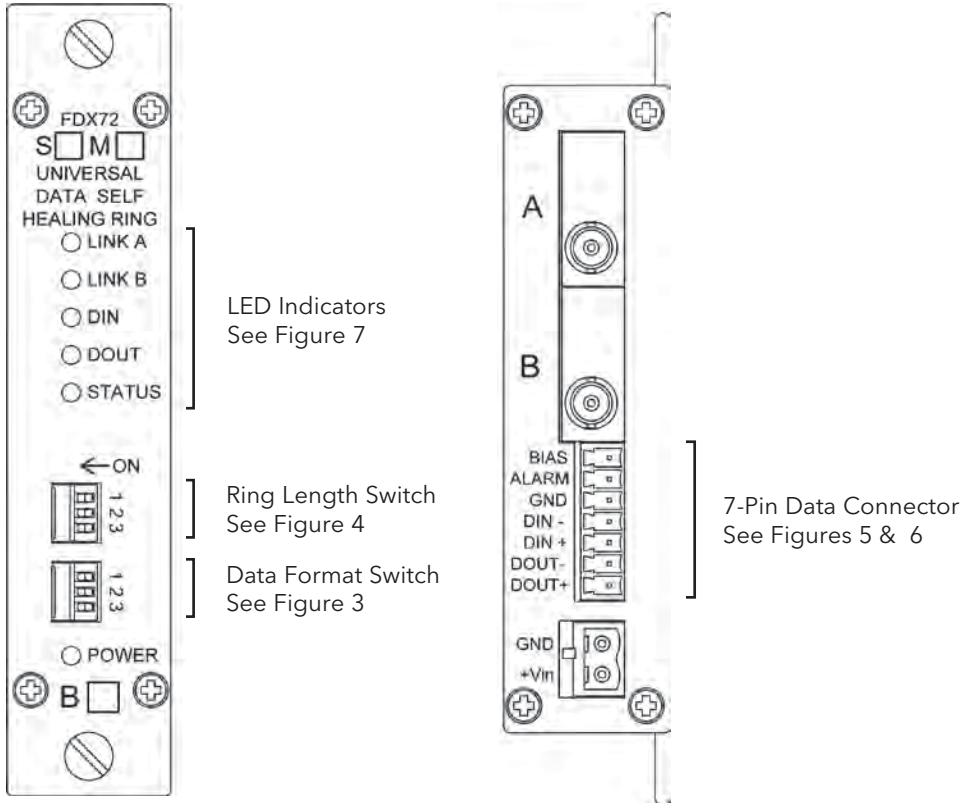
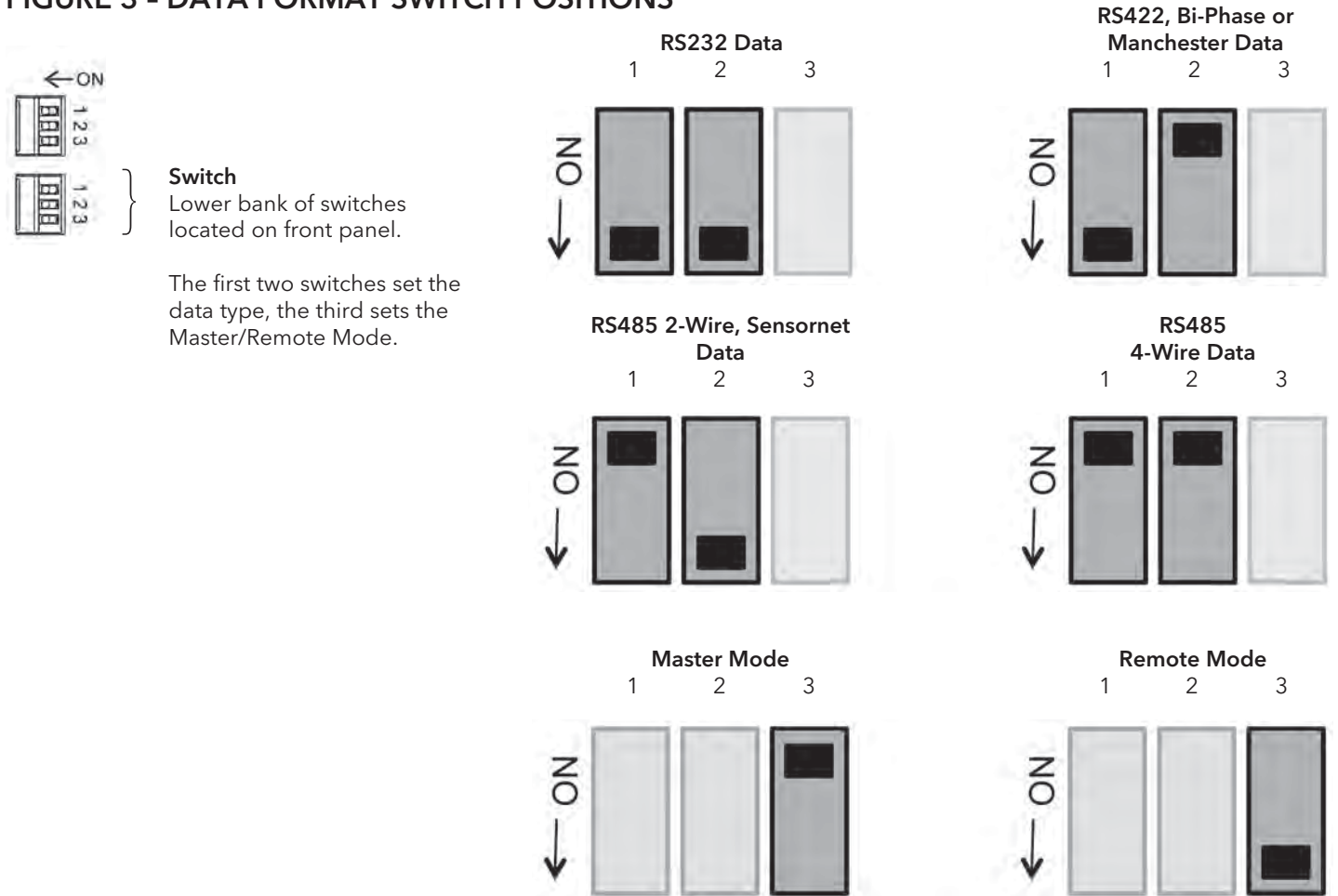

FIGURE 3 - DATA FORMAT SWITCH POSITIONS



There are two virtual data channels shared between all FDX72SHR units in a system: a Master channel and a Remote channel. The Master/Remote Mode switch sets the data channel used by the equipment connected to each FDX72SHR unit in the system. The behavior of a Master and Remote depends on the data type (set by switches 1 and 2):

**RS232, RS422, RS485 (4-wire):**

Units in Master Mode transmit data to all units set to Remote Mode.  
Units in Remote Mode transmit data to all units set to Master Mode.

There is no limit to the number of Masters or Remotes in a system as long as the equipment connected to the FDX72SHR can handle multiple Masters and multiple Remotes. Most applications requiring Master/Remote communications would use just one Master and multiple Remotes. Masters can communicate with all Slaves, but not with other Masters. Remotes can communicate with all Masters, but not with other Remotes.

**RS485 (2-wire):**

Units in Master Mode transmit data to all units set to Master Mode.  
Units in Remote Mode transmit data to all units set to Remote Mode.

The concept of Master and Remote are not used with RS485 (2-wire) mode. Rather, the Master/Remote Mode switch simply sets which of two independent data channels each unit will use. All Masters can communicate with each other, but not with Remotes. All Remotes can communicate with each other, but not with Masters.

FIGURE 4 - RING LENGTH SWITCH POSITIONS



**Switch**  
Upper bank of switches located on front panel.

Switch Position			Resulting Max Ring Length
1	2	3	
ON	ON	ON	100 km (default)
ON	ON	OFF	75 km
ON	OFF	ON	50 km
ON	OFF	OFF	20 km
OFF	ON	ON	10 km
OFF	ON	OFF	5 km
OFF	OFF	ON	2 km
OFF	OFF	OFF	1 km

For most applications, the Ring Length Switch can be left at default setting. For high data rate applications (>250Kbps) ring length should be set to minimize turn-around time.

FIGURE 5 - DATA CONNECTIONS

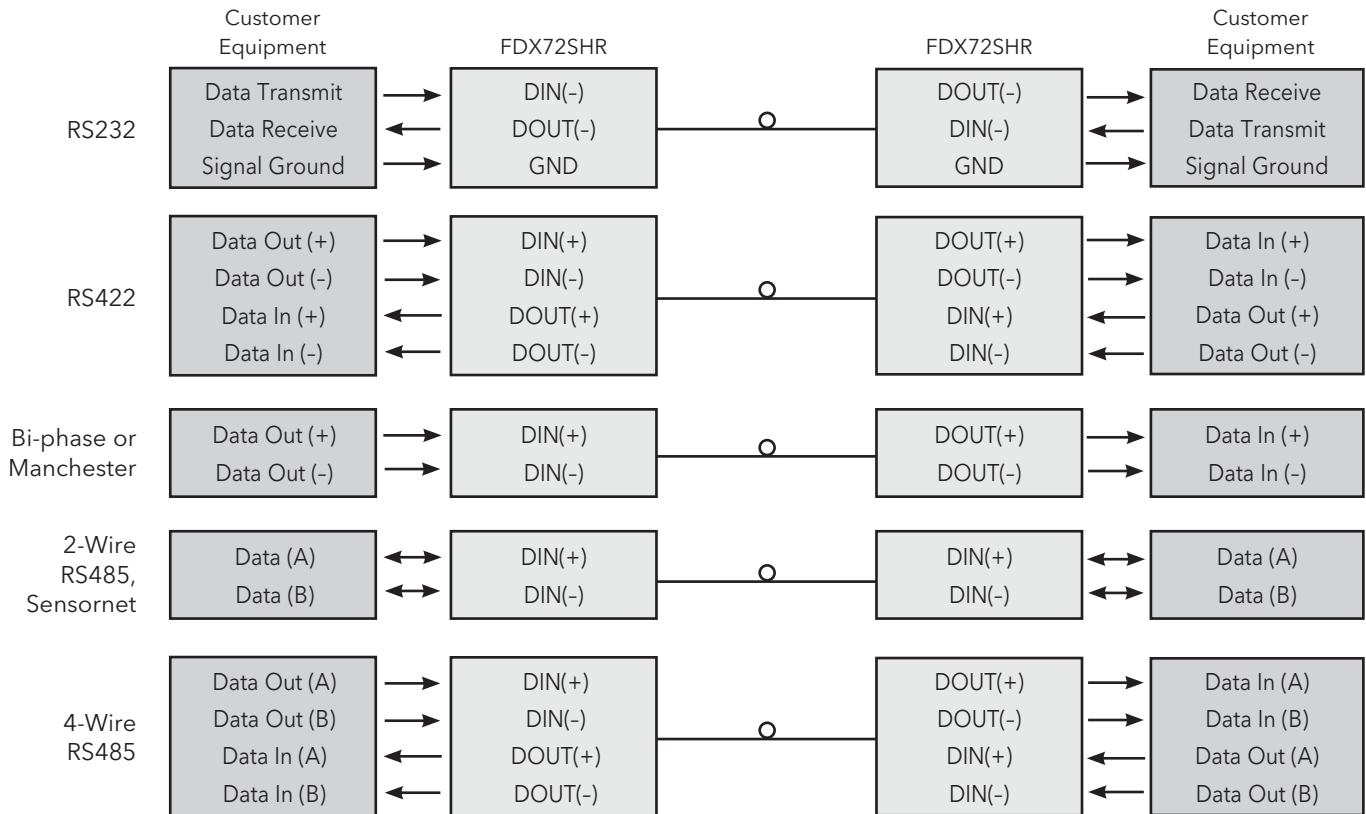

FIGURE 6 - 7-PIN DATA CONNECTOR



- BIAS** Current limited +5V connection. This terminal can be used as a connection for pull-up resistors, if required.
- ALARM** Alarm relay output. Indicates fault conditions. The relay is internally connected to the GND terminal when no faults are detected (i.e. a normally closed relay). The relay circuit opens when a fault is detected anywhere in the system.
- GND:** Signal ground reference. This terminal can be also be used as a connection for pull-down resistors, if required.
- DIN+/DIN-** Electrical data inputs. See **Figure 5** for data connections.
- DOUT+/DOUT-** Electrical data outputs. See **Figure 5** for data connections.

FIGURE 7 - LED INDICATORS

	LINK A	LINK B	DIN	DOUT	STATUS	POWER
GREEN	Unit In Sync	Unit In Sync	Data Activity	Data Activity	System OK. No Alarm	Unit Powered Up
RED	Unit Not In Sync	Unit Not In Sync	-	-	Fault Detected. Alarm Condition.	-
OFF	-	-	No Data Activity	No Data Activity	-	Unit Powered Down

**FIGURE 8 - FAULT CONDITIONS**

A fault condition is when a FDX72SHR unit system loses power or optical link. The FDX72SHR provides three indicators to help identify when and where fault conditions occur in a system:

1. ALARM relay output
2. STATUS LED
3. LINK A and LINK B LEDs

When a fault occurs, the ALARM relay on every FDX72SHR in the system goes from closed to open. In addition, the STATUS LED on every FDX72SHR in the system goes from solid green to solid red. The LINK A and LINK B LEDs can then be used to identify the actual location of the fault based on their color and pattern:

- Solid Green**      **Optical link has been established between this optical port and the adjacent FDX72SHR over fiber.**  
Furthermore, every other unit in the system is also reporting that link has been established. There are no faults in the system.
- Solid Red**      **Optical link over this port has been lost.**  
This could be due to a broken fiber, a bad connection, or loss of power at the adjacent unit.
- Blinking Green/Red**      **Optical link has been established between this optical port and the adjacent FDX72SHR over fiber.**  
However, a fault condition has been detected somewhere in the system. The LINK LED will be green for a period of time, and then flash red some number of times. The number of red flashes indicates the location of the fault by "hops" around the ring. If the LED flashes red three times, then the location of the fault is three hops away (i.e. three FDX72SHR units away). For larger systems with faults greater than 9 hops away, the LED will use a combination of long and short red flashes. Each long flash indicates 10 hops. Each short flash indicates 1 hop. For example, a fault 47 hops away would be encoded as 4 long red flashes, followed immediately by 7 short red flashes. The pattern repeats indefinitely until the fault is resolved.

**EXAMPLE**

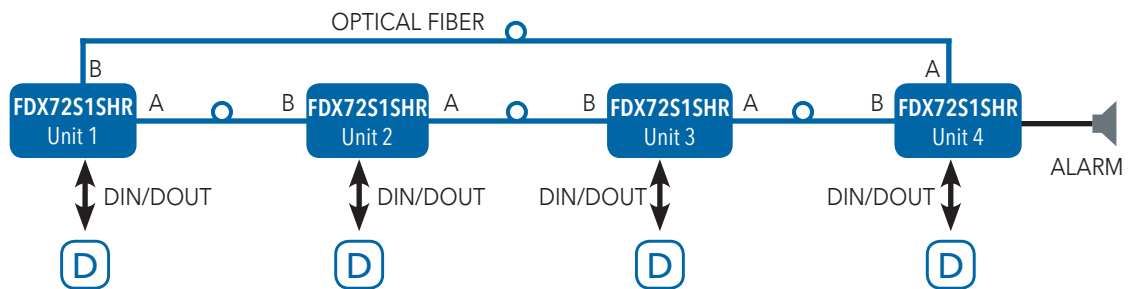

The diagram above shows the connections for a system of four FDX72SHR units. The fourth unit has an audible alarm connected to its ALARM relay. The alarm relay is normally closed. Every unit's LINK A, LINK B, and STATUS LEDs will be solid green.

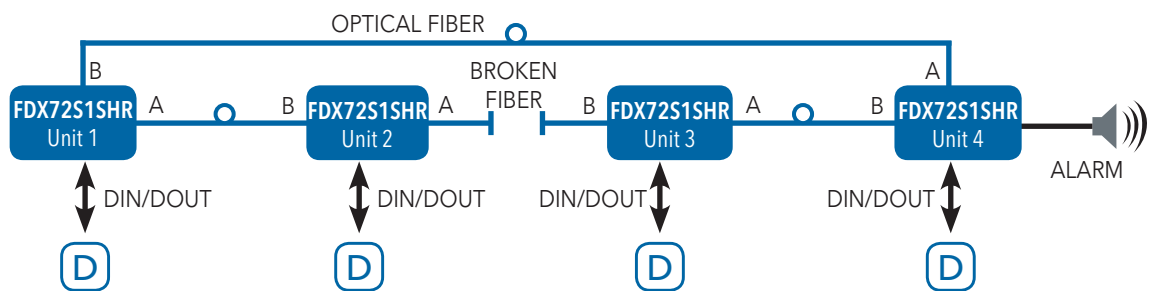

The diagram above shows how this system will respond to an optical fiber break between Unit 2 and Unit 3. The ALARM relay on every node will go from closed to an open circuit to indicate an alarm condition and the STATUS LED on every node will go from solid green to solid red. The audible alarm connected to unit 4 will sound. The LINK A and LINK B LEDs on each unit will identify where the fault occurred:

- Unit 1** The LINK A LED will be green for a time, then flash red 1 time. The LINK B LED will be green for a time, then flash red 2 times.
- Unit 2** The LINK A LED will be solid red. The LINK B LED will be green for a time, then flash red 3 times.
- Unit 3** The LINK A LED will be green for a time, then flash red 3 times. The LINK B LED will be solid red.
- Unit 4** The LINK A LED will be green for a time, then flash red 2 times. The LINK B LED will be green for a time, then flash red 1 time.

# MECHANICAL INSTALLATION INSTRUCTIONS

## INSTALLATION CONSIDERATIONS

This fiber-optic link is supplied as a Standalone/Rack module. Units should be installed in dry locations protected from extremes of temperature and humidity.

## C1-US, C1-EU, C1-AU OR C1-CH CARD CAGE RACKS

**CAUTION:** Although the units are hot-swappable and may be installed without turning power off to the rack, ComNet recommends that the power supply be turned off and that the rack power supply is disconnected from any power source. **Note:** Remove electrical connector before installing in card cage rack.

1. Make sure that the card is oriented right side up, and slide it into the card guides in the rack until the edge connector at the back of the card seats in the corresponding slot in the rack's connector panel. Seating may require thumb pressure on the top and bottom of the card's front panel.

**CAUTION:** Take care not to press on any of the LEDs.

2. Tighten the two thumb screws on the card until the front panel of the card is seated against the front of the rack.

**WARNING:** Unit is to be used with a Listed Class 2 or LPS power supply.

## IMPORTANT SAFEGUARDS:

- A) **Elevated Operating Ambient** - If installed in a closed or multi-unit rack assembly, the operating ambient temperature of the rack environment may be greater than room ambient. Therefore, consideration should be given to installing the equipment in an environment compatible with the maximum ambient temperature (T<sub>ma</sub>) specified by the manufacturer.
- B) **Reduced Air Flow** - Installation of the equipment in a rack should be such that the amount of air flow required for safe operation of the equipment is not compromised.

## FIGURE A

Dimensions are for a standard ComNet™ one slot module

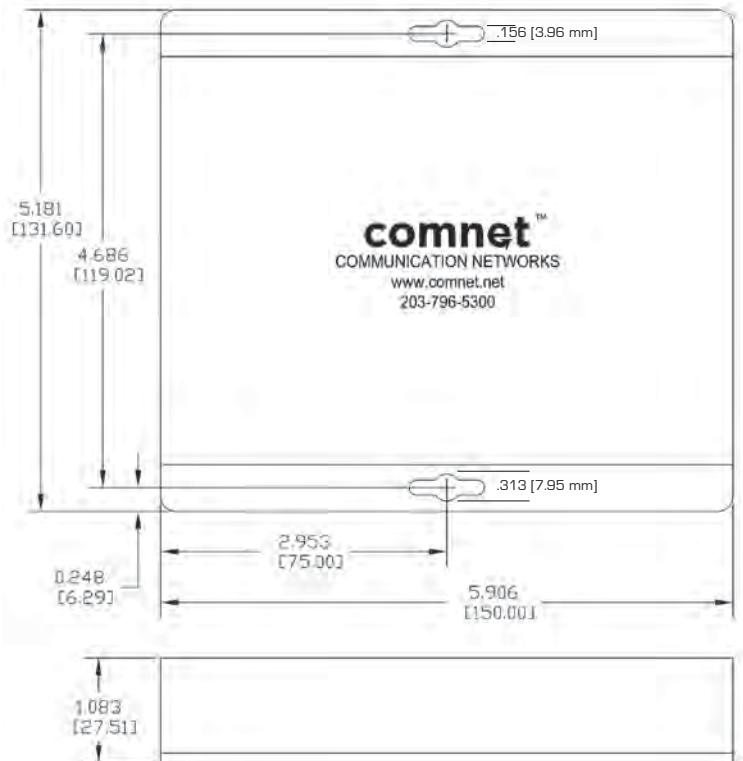

MADE IN THE  
**USA**

**comnet**  
Communication Networks

3 CORPORATE DRIVE | DANBURY, CT 06810 | USA  
T: 203.796.5300 | F: 203.796.5303 | TECH SUPPORT: 1.888.678.9427 | INFO@COMNET.NET  
8 TURNBERRY PARK ROAD | GILDERSOME | MORLEY | LEEDS, UK LS27 7LE  
T: +44 (0)113 307 6400 | F: +44 (0)113 253 7462 | INFO-EUROPE@COMNET.NET